

60도 삼각비

(Trigonometric Ratio of 60 degree)

Trigonometric Ratio of 60 degree

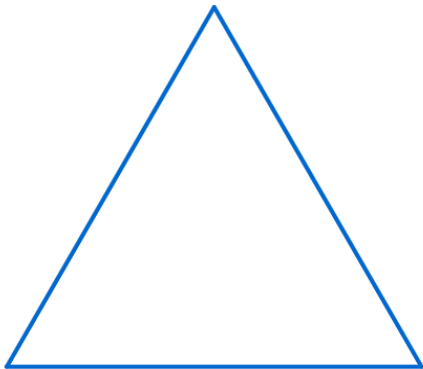

Trigonometric Ratio of 60 degree

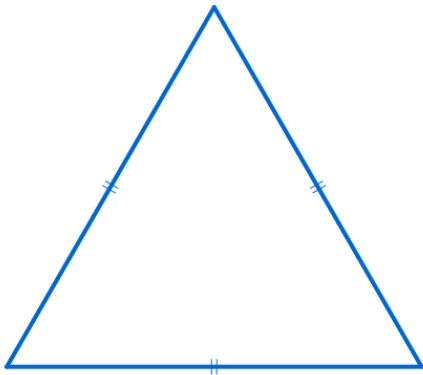

Trigonometric Ratio of 60 degree

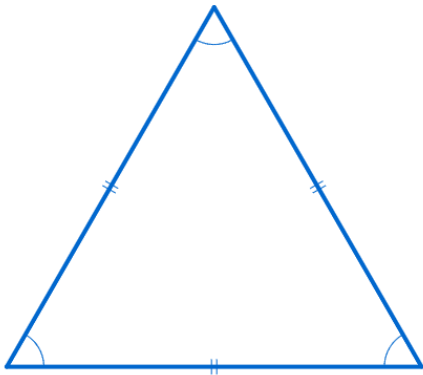

Trigonometric Ratio of 60 degree

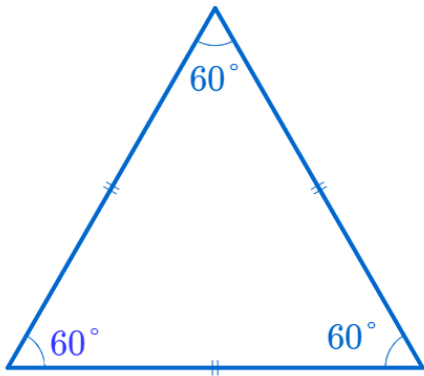

Trigonometric Ratio of 60 degree

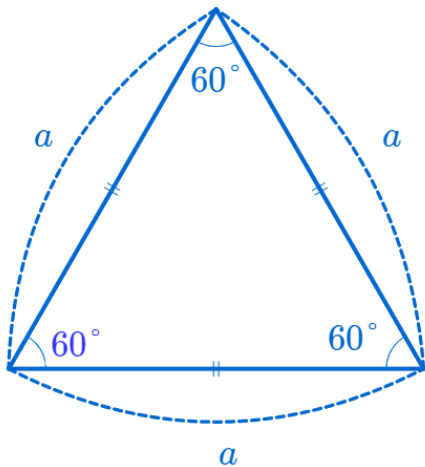

Trigonometric Ratio of 60 degree

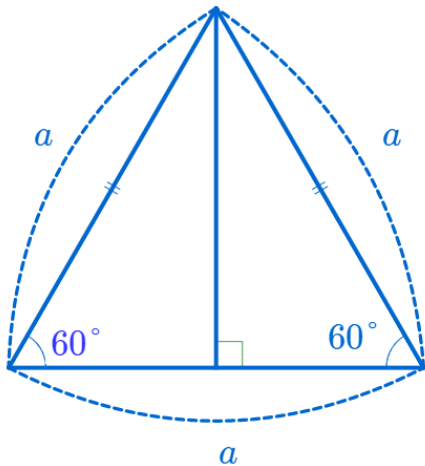

Trigonometric Ratio of 60 degree

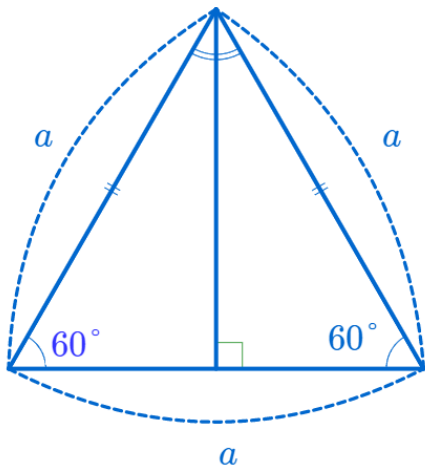

Trigonometric Ratio of 60 degree

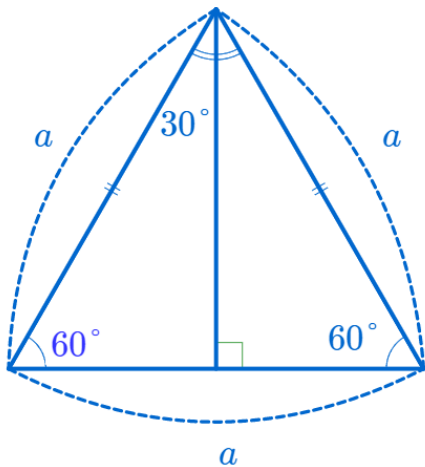

Trigonometric Ratio of 60 degree

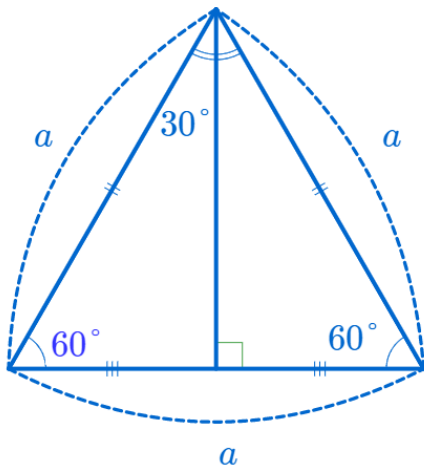

Trigonometric Ratio of 60 degree

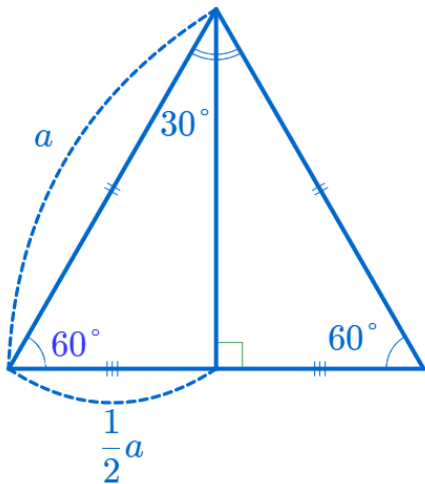

Trigonometric Ratio of 60 degree

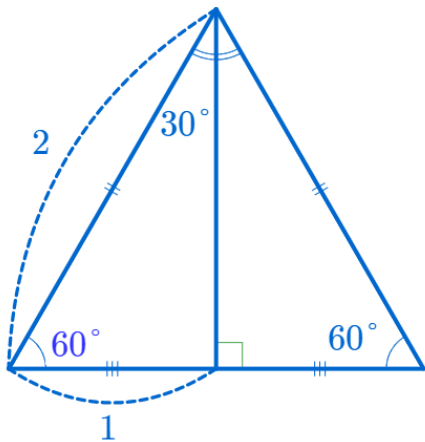

Trigonometric Ratio of 60 degree

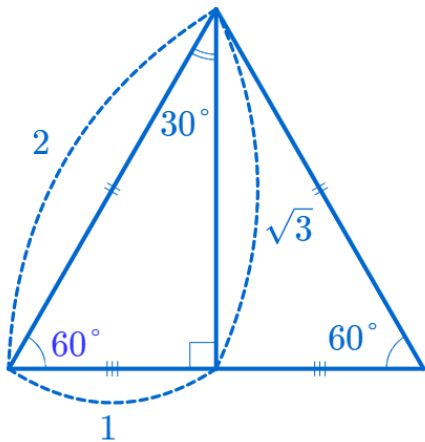

Trigonometric Ratio of 60 degree

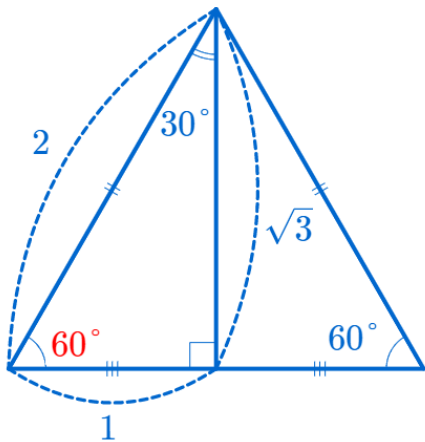

$$\sin 60^\circ = \frac{\sqrt{3}}{2}$$

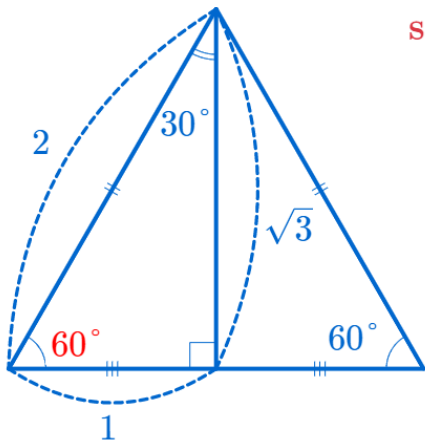

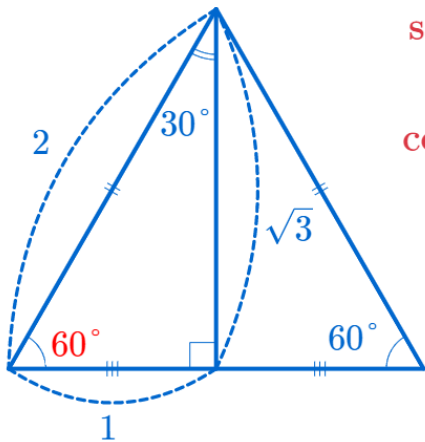

$$\sin 60^\circ = \frac{\sqrt{3}}{2}$$

$$\cos 60^\circ = \frac{1}{2}$$

Trigonometric Ratio of 60 degree

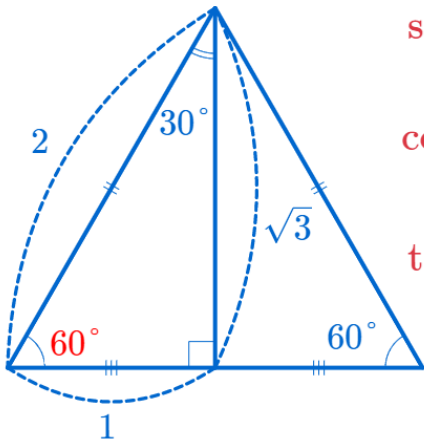

$$\sin 60^\circ = \frac{\sqrt{3}}{2}$$

$$\cos 60^\circ = \frac{1}{2}$$

$$\tan 60^\circ = \frac{\sqrt{3}}{1} = \sqrt{3}$$

Github:

<https://min7014.github.io/math20200121001.html>

Click or paste URL into the URL search bar, and you can see a picture moving.