

사이클로이드 곡선이 꺾이지 않는 이유는
무엇인가?
(Why is the cycloid curve not kinked?)

Why is the cycloid curve not kinked?

▶ Start

Why is the cycloid curve not kinked?

▶ Start



Why is the cycloid curve not kinked?

▶ Start

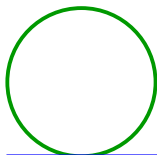

Why is the cycloid curve not kinked?

▶ Start



Why is the cycloid curve not kinked?

▶ Start

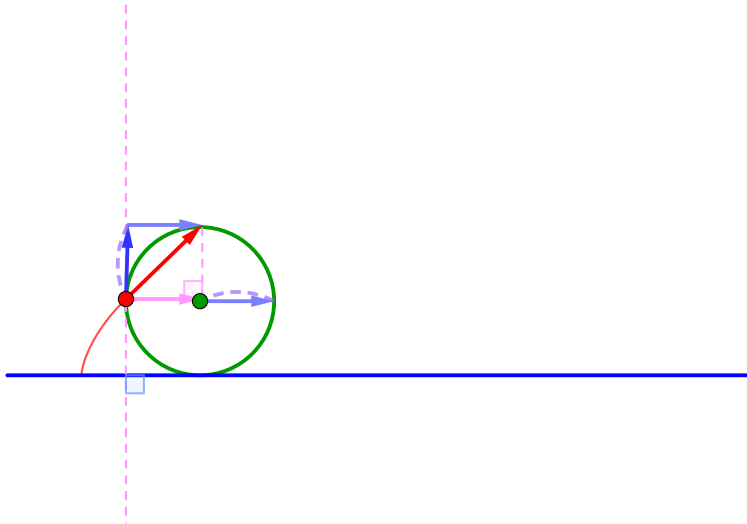

Why is the cycloid curve not kinked?

▶ Start

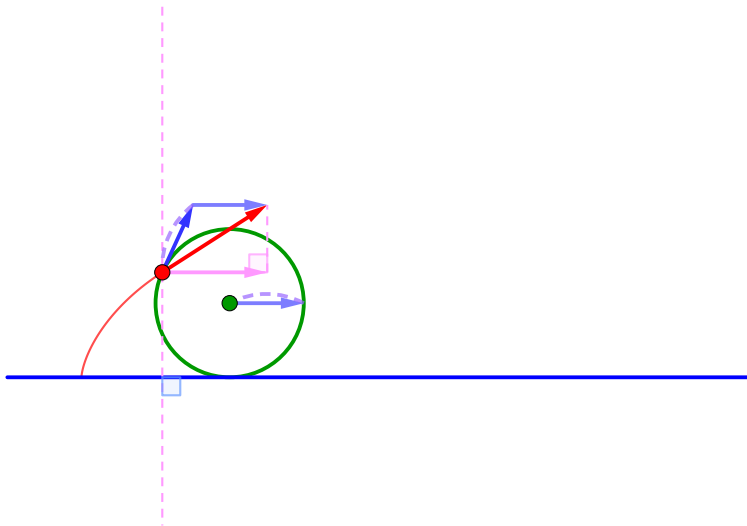

Why is the cycloid curve not kinked?

▶ Start

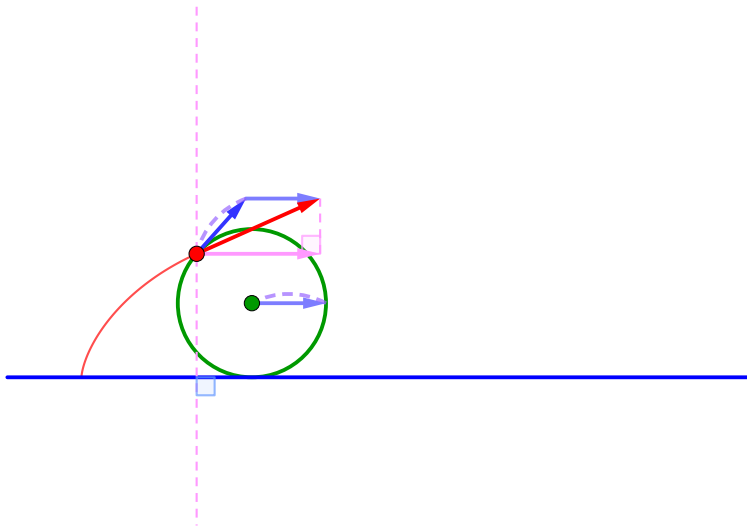

Why is the cycloid curve not kinked?

▶ Start

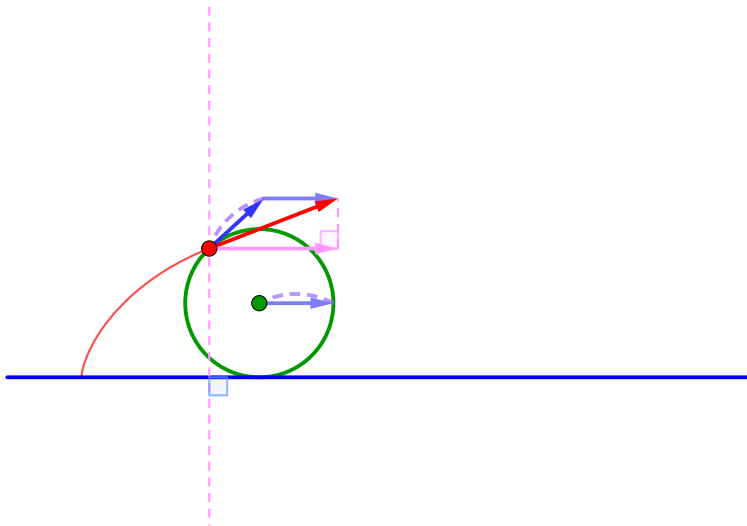

Why is the cycloid curve not kinked?

▶ Start

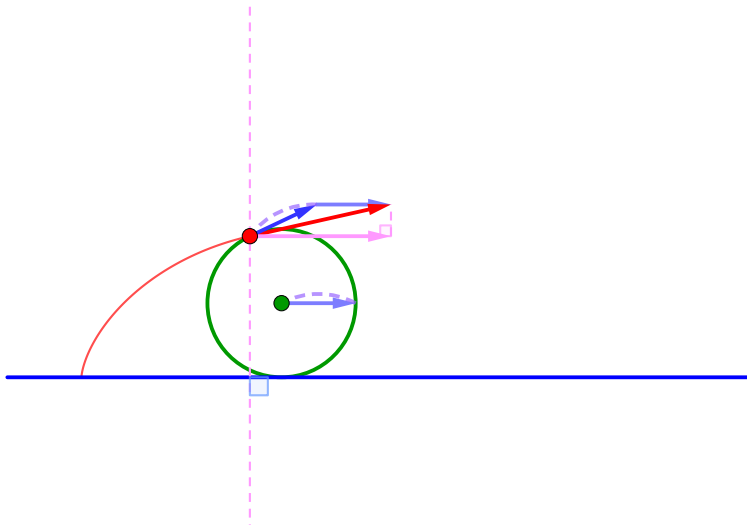

Why is the cycloid curve not kinked?

▶ Start

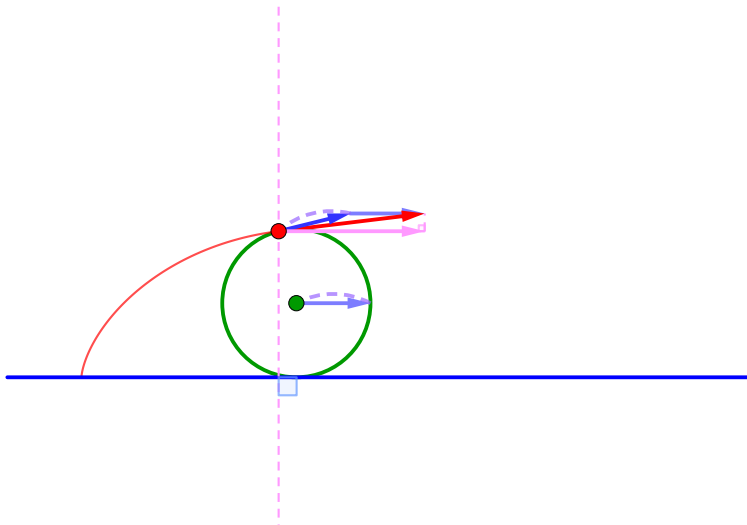

Why is the cycloid curve not kinked?

▶ Start

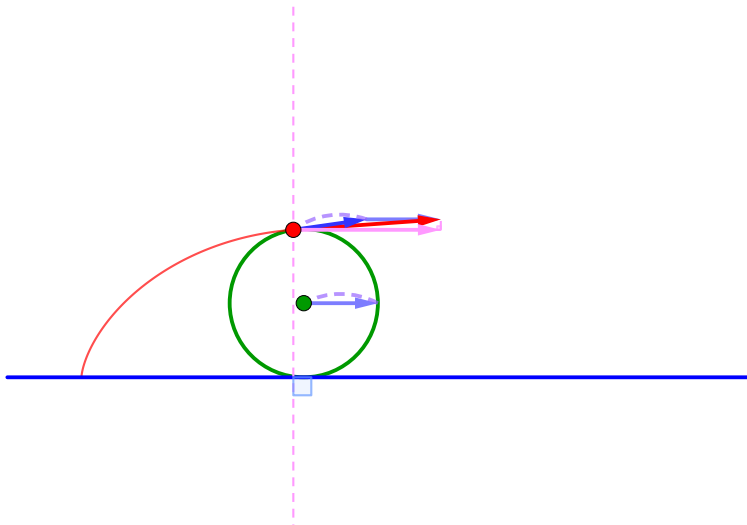

Why is the cycloid curve not kinked?

▶ Start

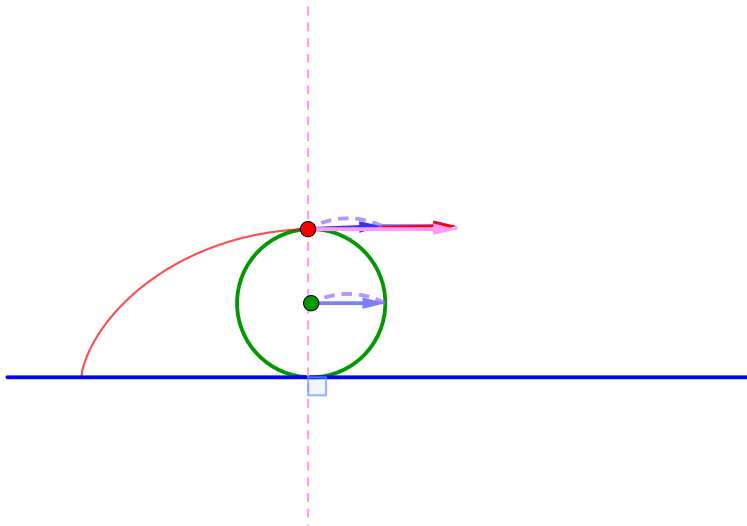

Why is the cycloid curve not kinked?

▶ Start

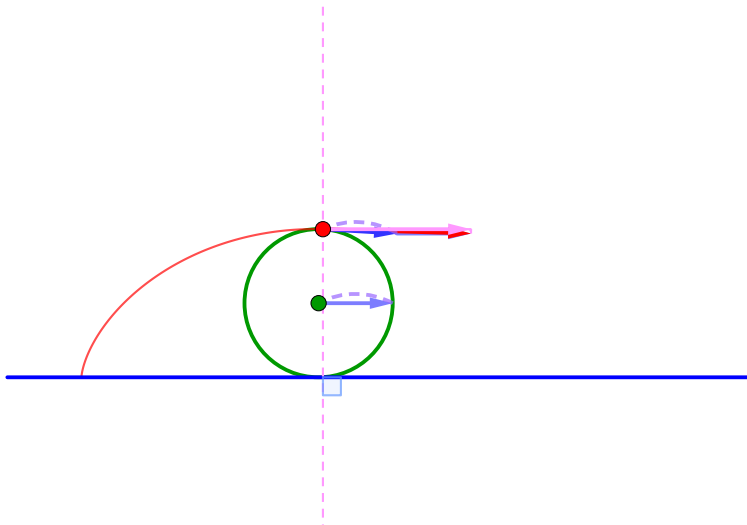

Why is the cycloid curve not kinked?

▶ Start

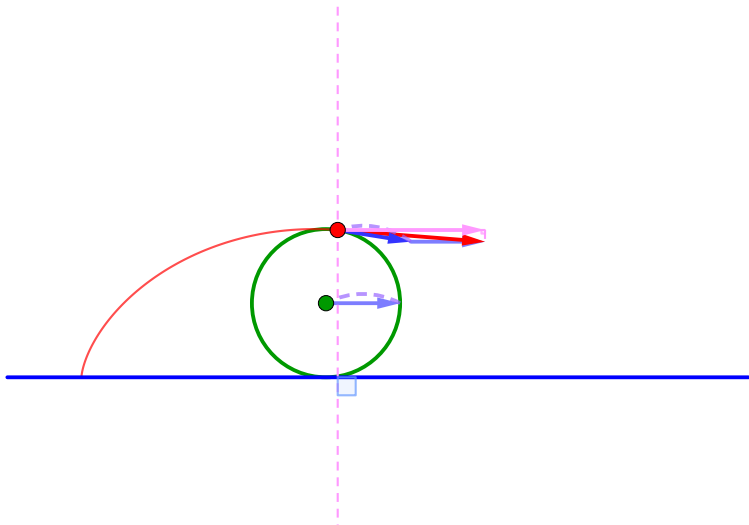

Why is the cycloid curve not kinked?

▶ Start

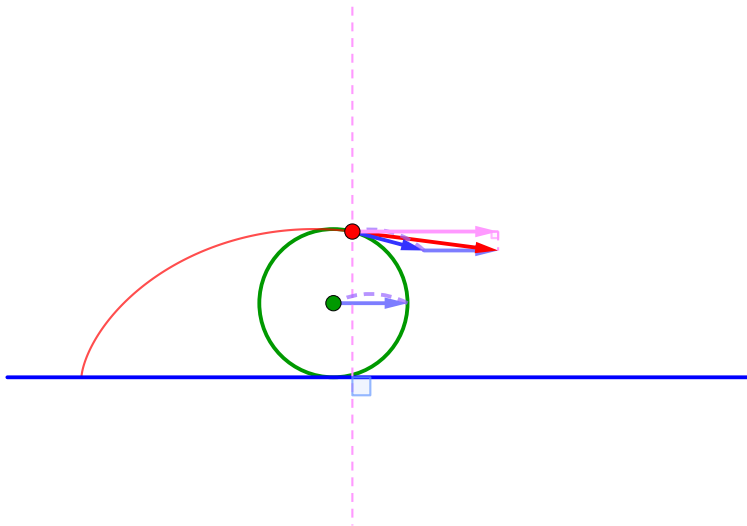

Why is the cycloid curve not kinked?

▶ Start

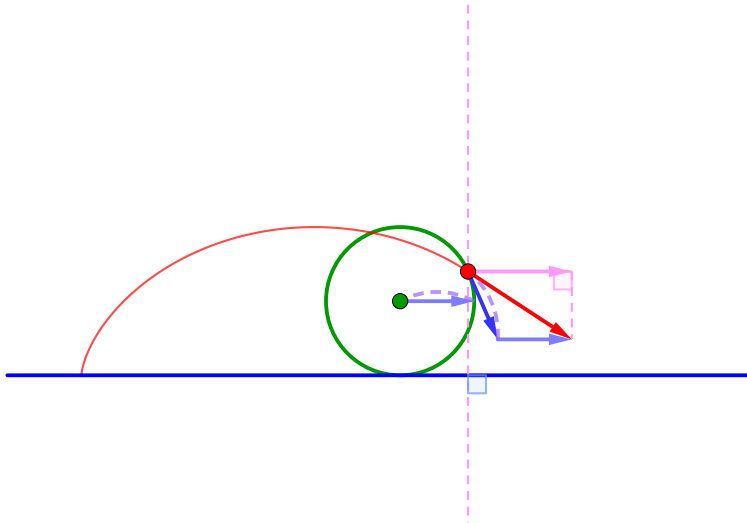

Why is the cycloid curve not kinked?

▶ Start

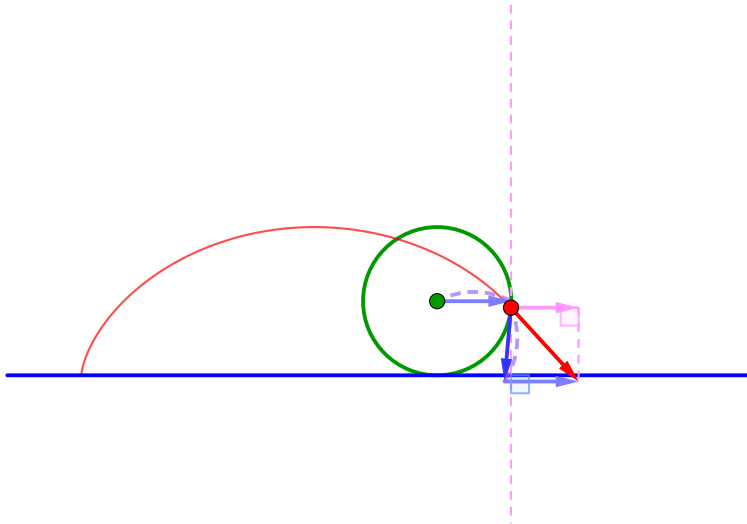

Why is the cycloid curve not kinked?

▶ Start

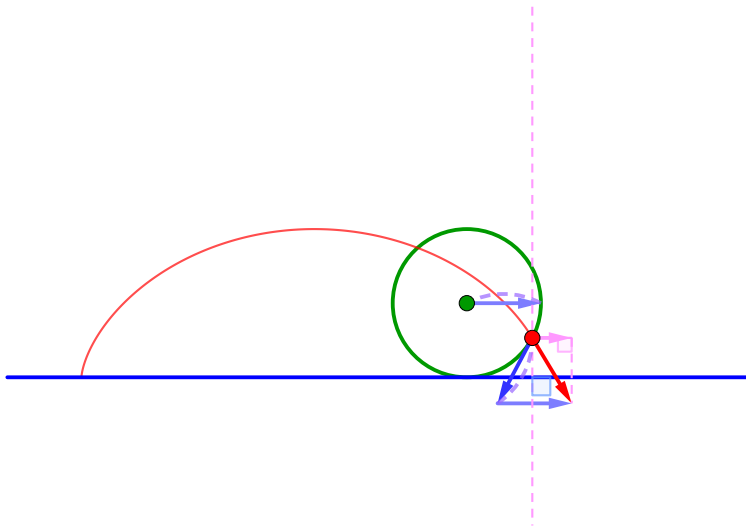

Why is the cycloid curve not kinked?

▶ Start

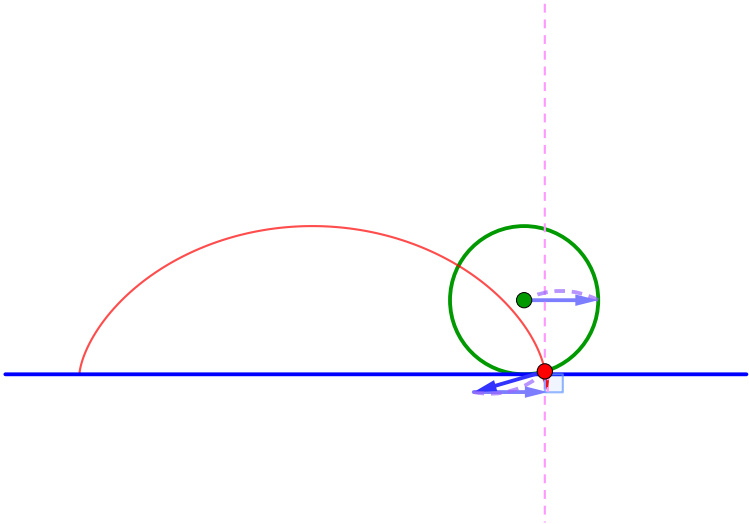

Why is the cycloid curve not kinked?

▶ Start

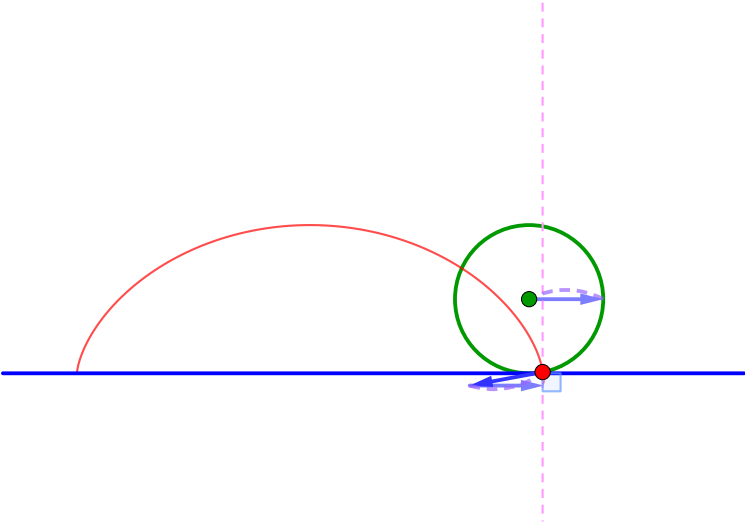

Why is the cycloid curve not kinked?

▶ Start

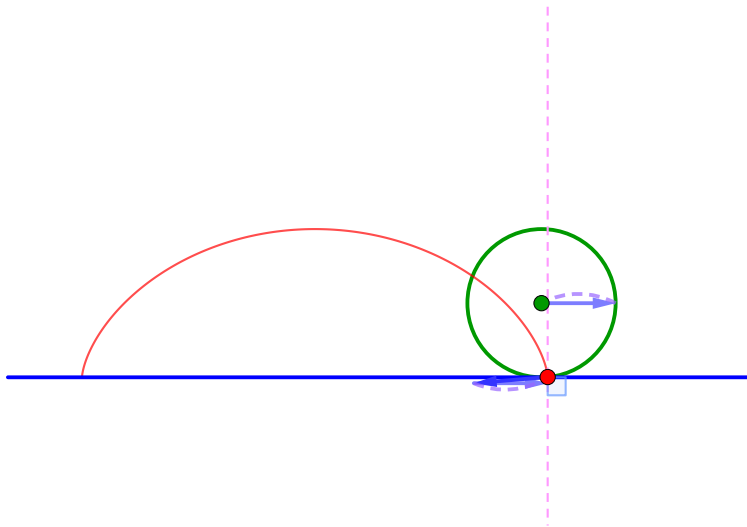

Why is the cycloid curve not kinked?

▶ Start

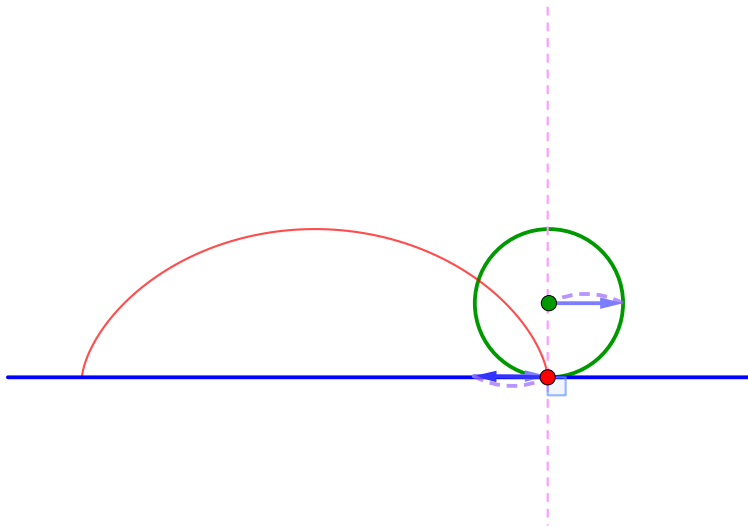

Why is the cycloid curve not kinked?

▶ Start

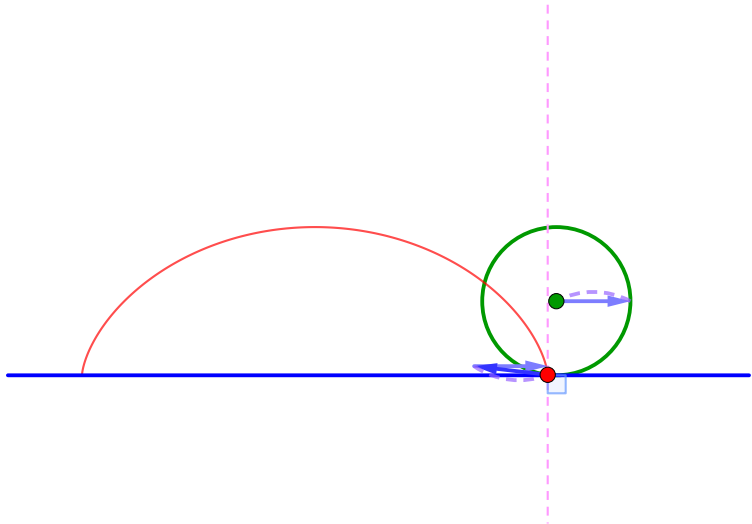

Why is the cycloid curve not kinked?

▶ Start

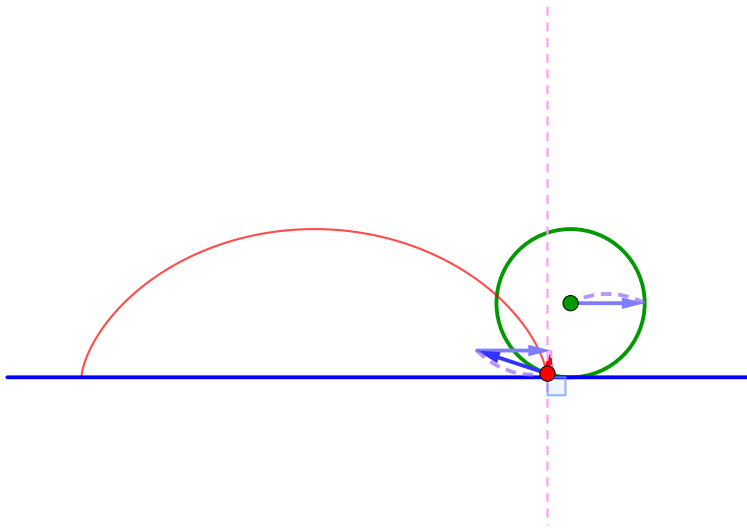

Why is the cycloid curve not kinked?

▶ Start

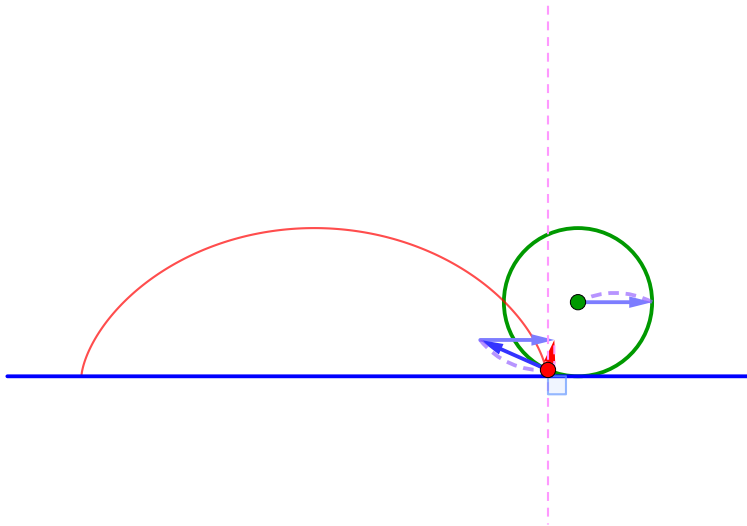

Why is the cycloid curve not kinked?

▶ Start

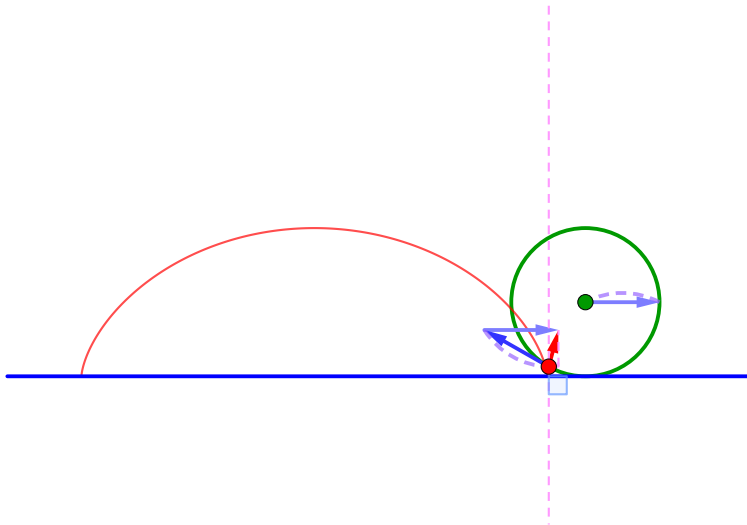

Why is the cycloid curve not kinked?

▶ Start

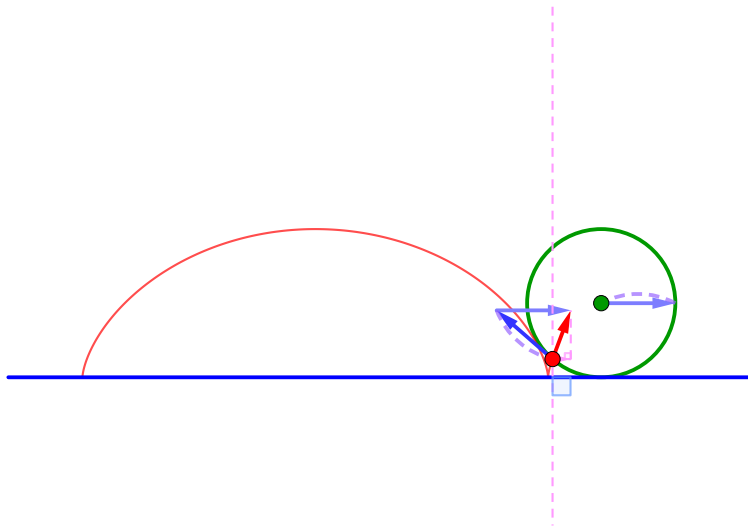

Why is the cycloid curve not kinked?

▶ Start

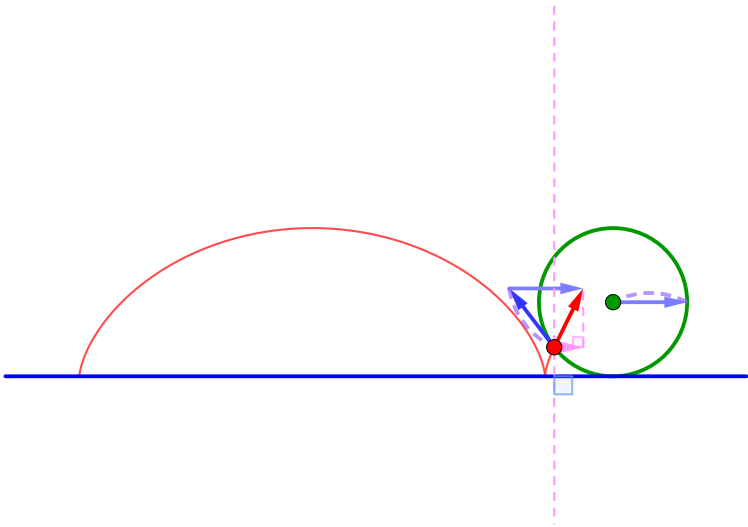

Why is the cycloid curve not kinked?

▶ Start

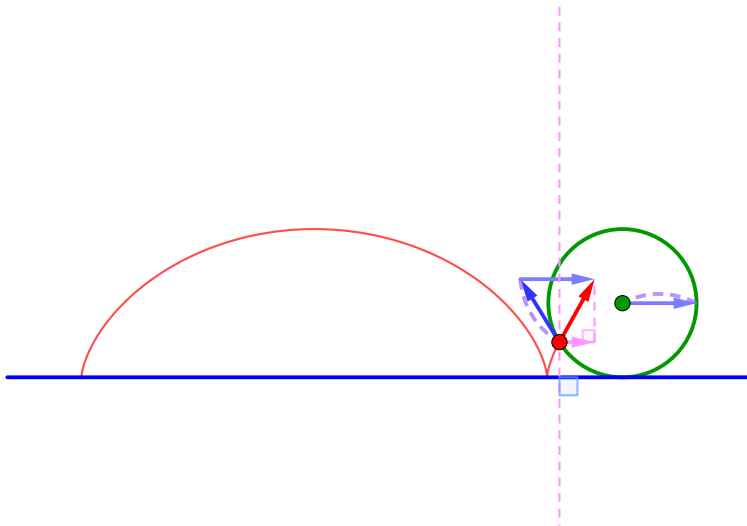

Why is the cycloid curve not kinked?

▶ Start

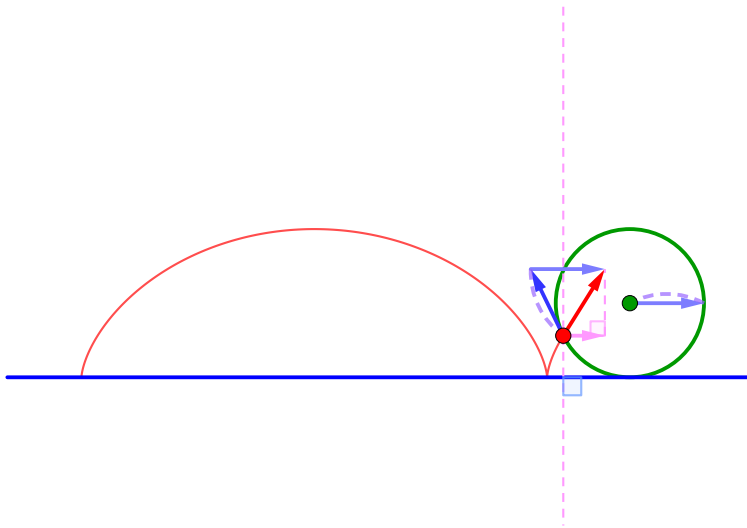

Why is the cycloid curve not kinked?

▶ Start

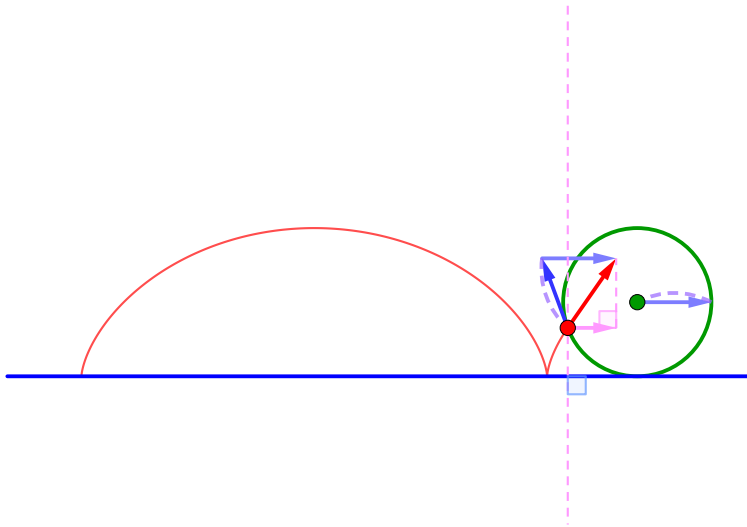

Why is the cycloid curve not kinked?

▶ Start

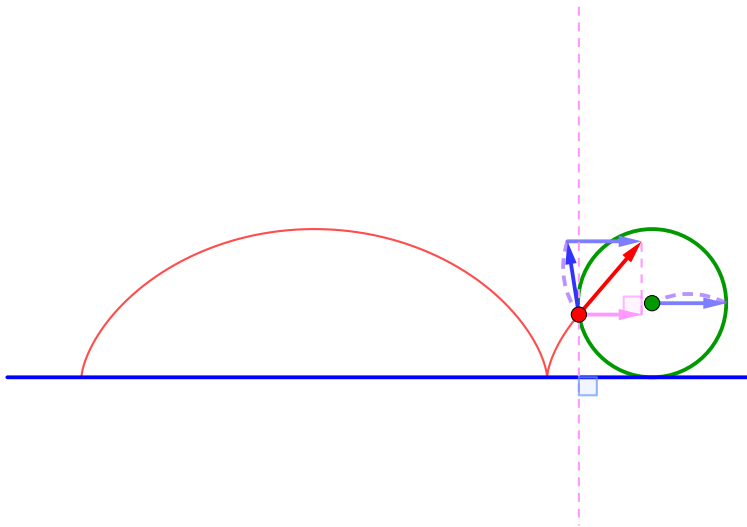

Why is the cycloid curve not kinked?

▶ Start

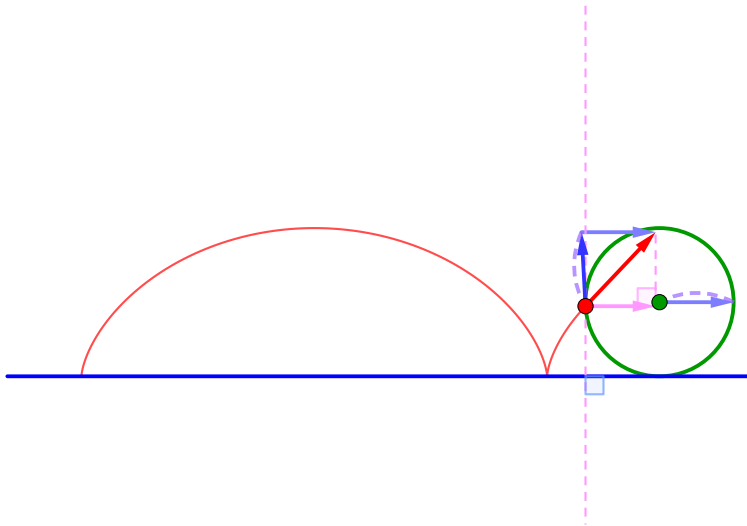

Why is the cycloid curve not kinked?

▶ Start

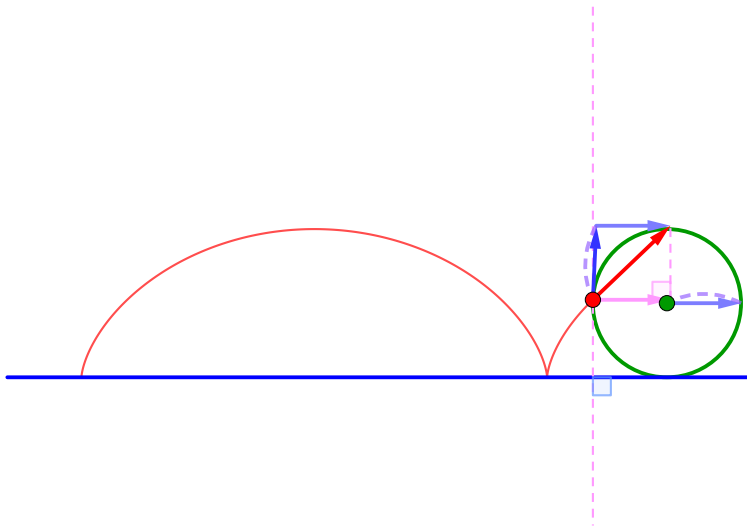

Why is the cycloid curve not kinked?

▶ Start

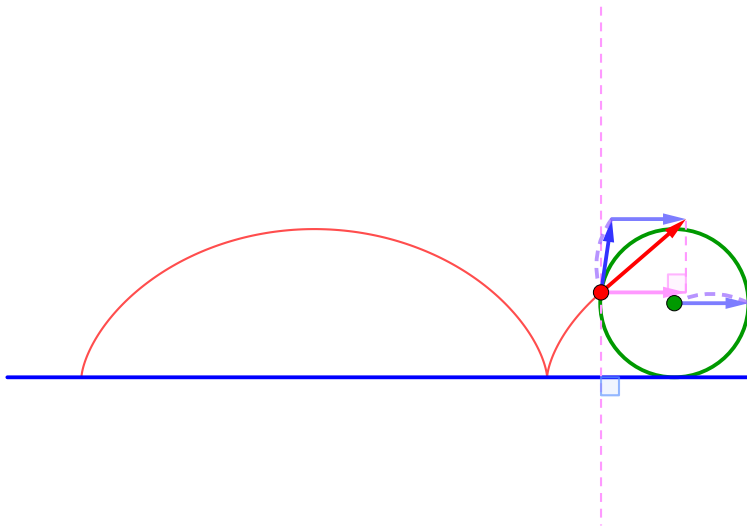

Why is the cycloid curve not kinked?

▶ Start

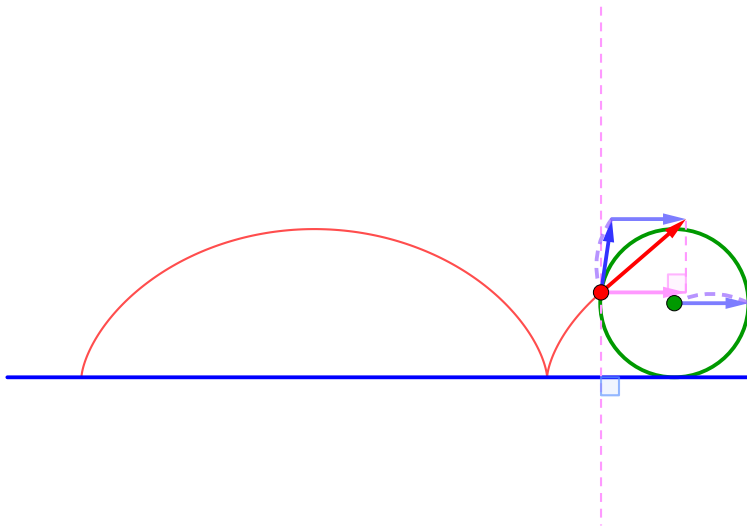

Why is the cycloid curve not kinked?

▶ Home

