

$$a > b \Leftrightarrow \sqrt{a} > \sqrt{b} \quad (a, b > 0)$$

$$a > b \Leftrightarrow \sqrt{a} > \sqrt{b} \quad (a, b > 0)$$

$$a > b \Leftrightarrow \sqrt{a} > \sqrt{b} \quad (a, b > 0)$$

$$a > b \Leftrightarrow \sqrt{a} > \sqrt{b} \quad (a, b > 0)$$

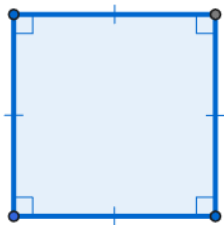

$$a > b \Leftrightarrow \sqrt{a} > \sqrt{b} \quad (a, b > 0)$$

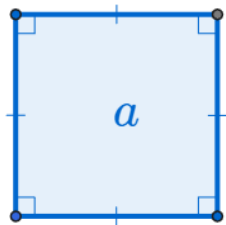

$$a > b \Leftrightarrow \sqrt{a} > \sqrt{b} \quad (a, b > 0)$$

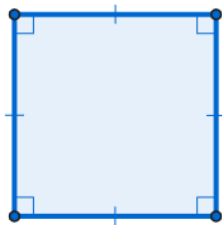
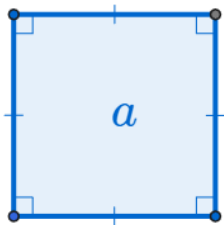

$$a > b \Leftrightarrow \sqrt{a} > \sqrt{b} \quad (a, b > 0)$$

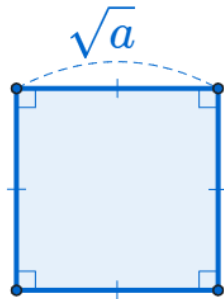
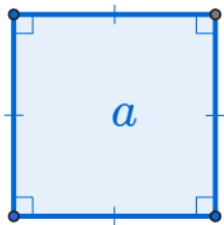

$$a > b \Leftrightarrow \sqrt{a} > \sqrt{b} \quad (a, b > 0)$$

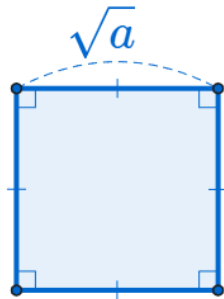
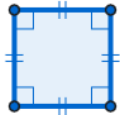
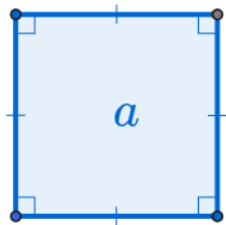

$$a > b \Leftrightarrow \sqrt{a} > \sqrt{b} \quad (a, b > 0)$$

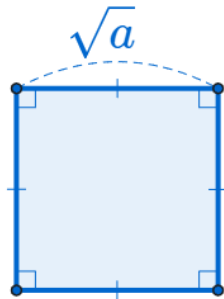
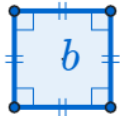
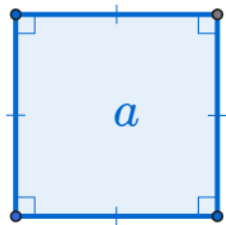

$$a > b \Leftrightarrow \sqrt{a} > \sqrt{b} \quad (a, b > 0)$$

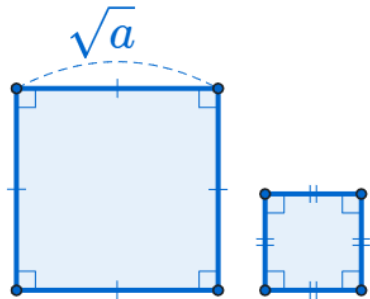
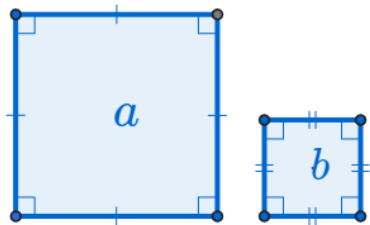

$$a > b \Leftrightarrow \sqrt{a} > \sqrt{b} \quad (a, b > 0)$$

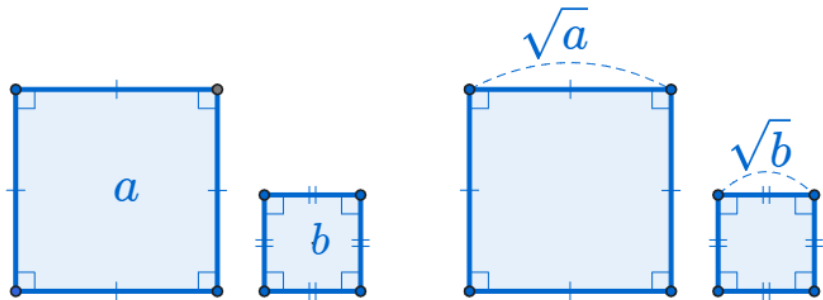

$$a > b \Leftrightarrow \sqrt{a} > \sqrt{b} \quad (a, b > 0)$$

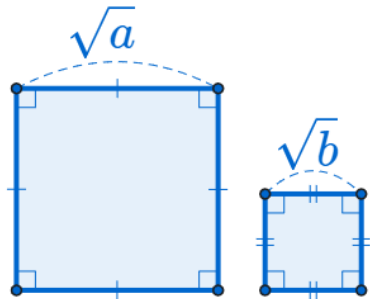
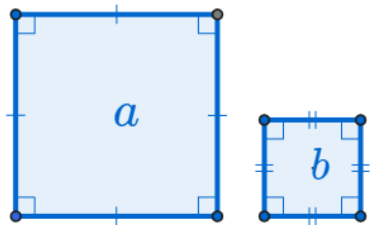

$$a > b$$

$$a > b \Leftrightarrow \sqrt{a} > \sqrt{b} \quad (a, b > 0)$$

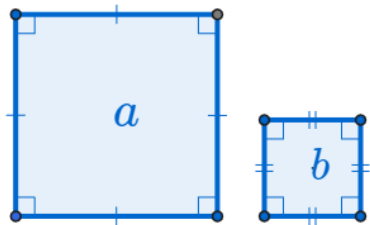

$$a > b$$

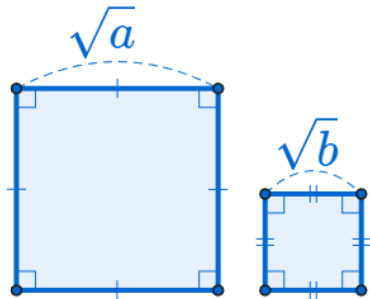

$$\sqrt{a} > \sqrt{b}$$

$$a > b \Leftrightarrow \sqrt{a} > \sqrt{b} \quad (a, b > 0)$$

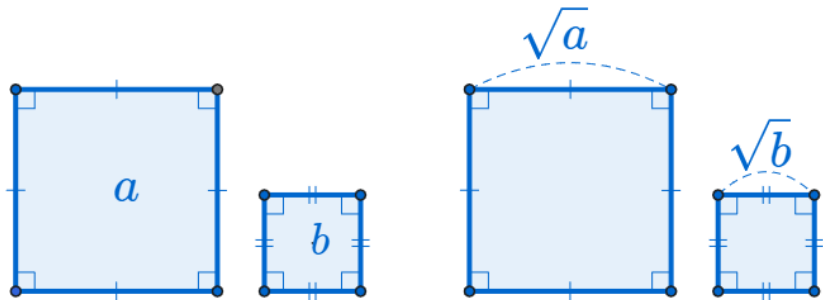

$$a > b \Leftrightarrow \sqrt{a} > \sqrt{b}$$

$$a > b \Leftrightarrow \sqrt{a} > \sqrt{b} \quad (a, b > 0)$$

YouTube: <https://youtu.be/Ih-c128phI8>

AlgeoMath: <http://me2.do/xTU2MCOQ>

Click or paste URL into the URL search bar, and you can see a picture moving.